

I am not Otto
Von Bismark!

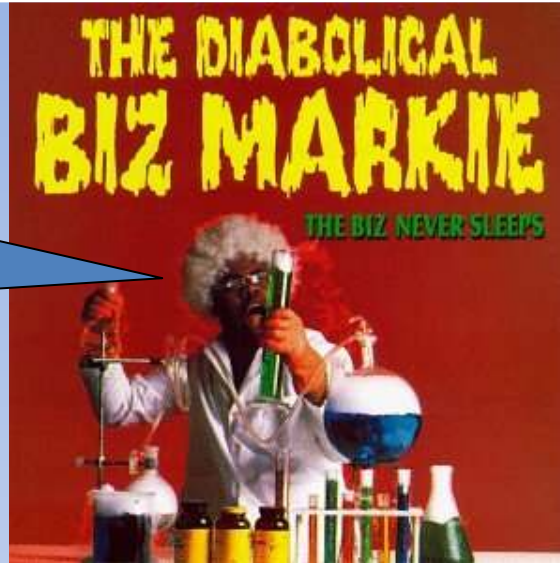

Around The World

Shout out to Kailen













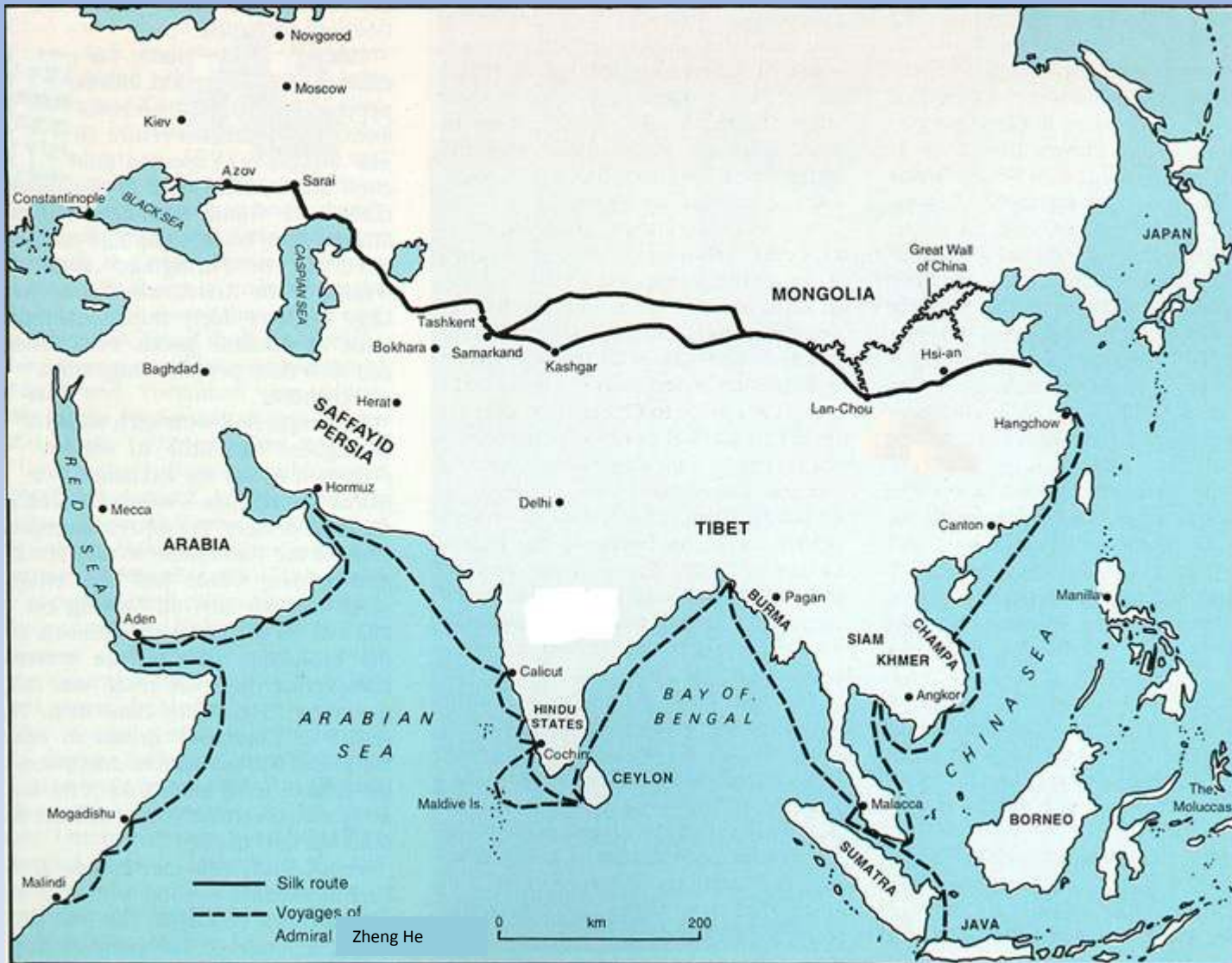

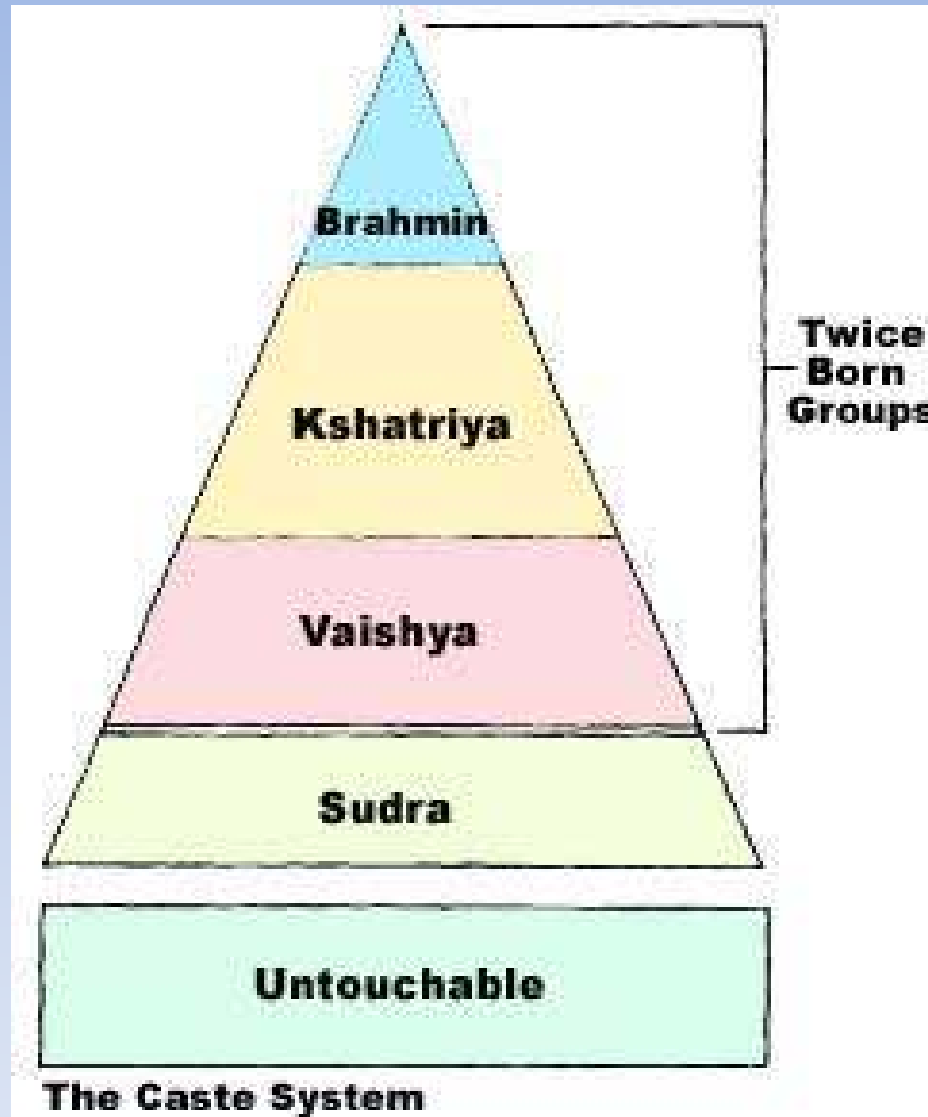



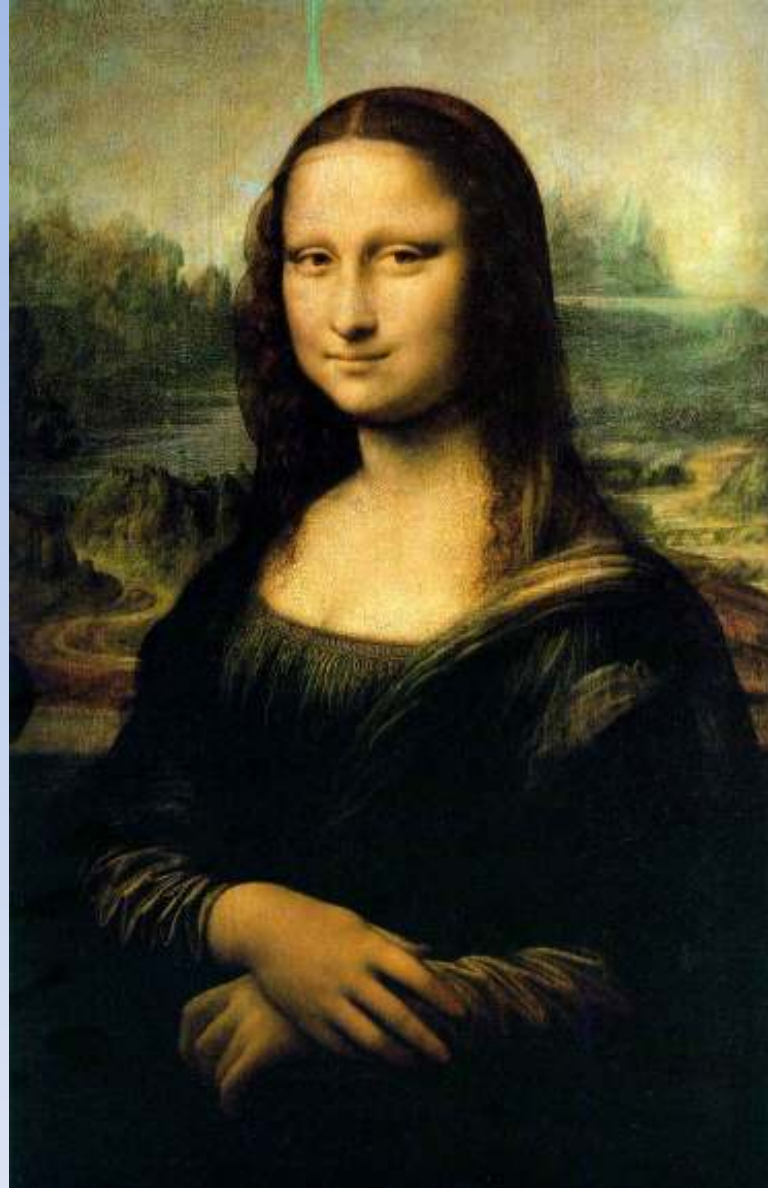





Which diagram shows the correct social hierarchy of Spain's colonial empire in the Western Hemisphere?

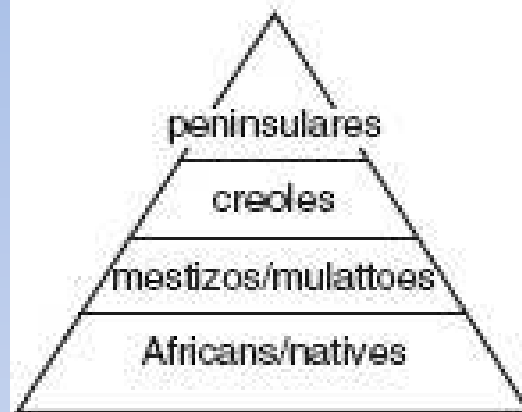

(1)

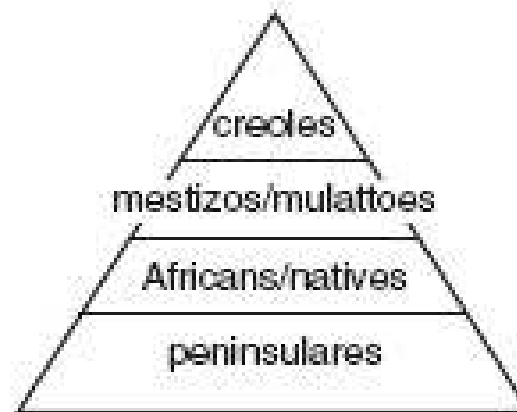

(3)

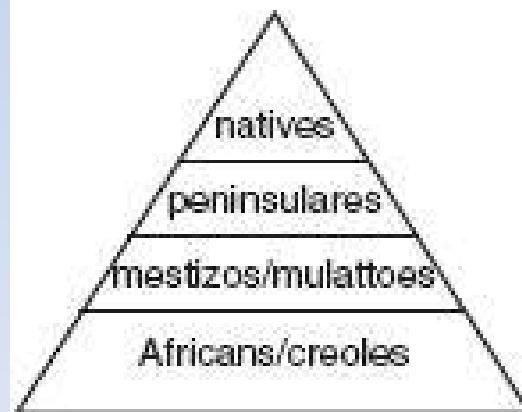

(2)

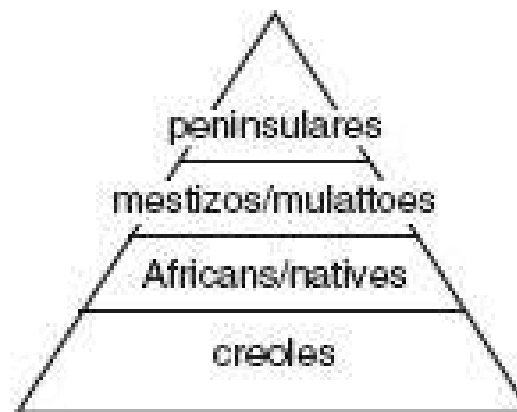

(4)









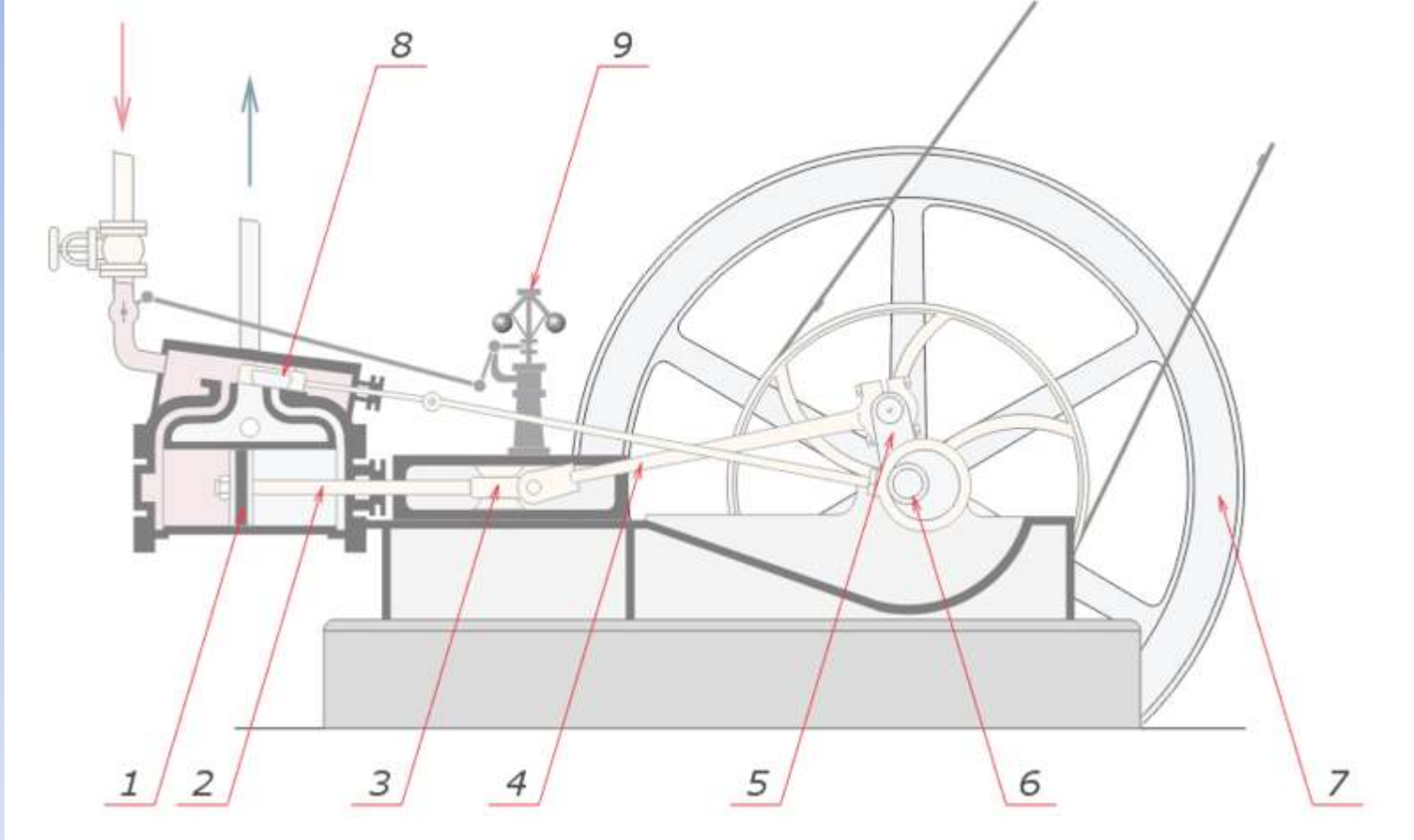

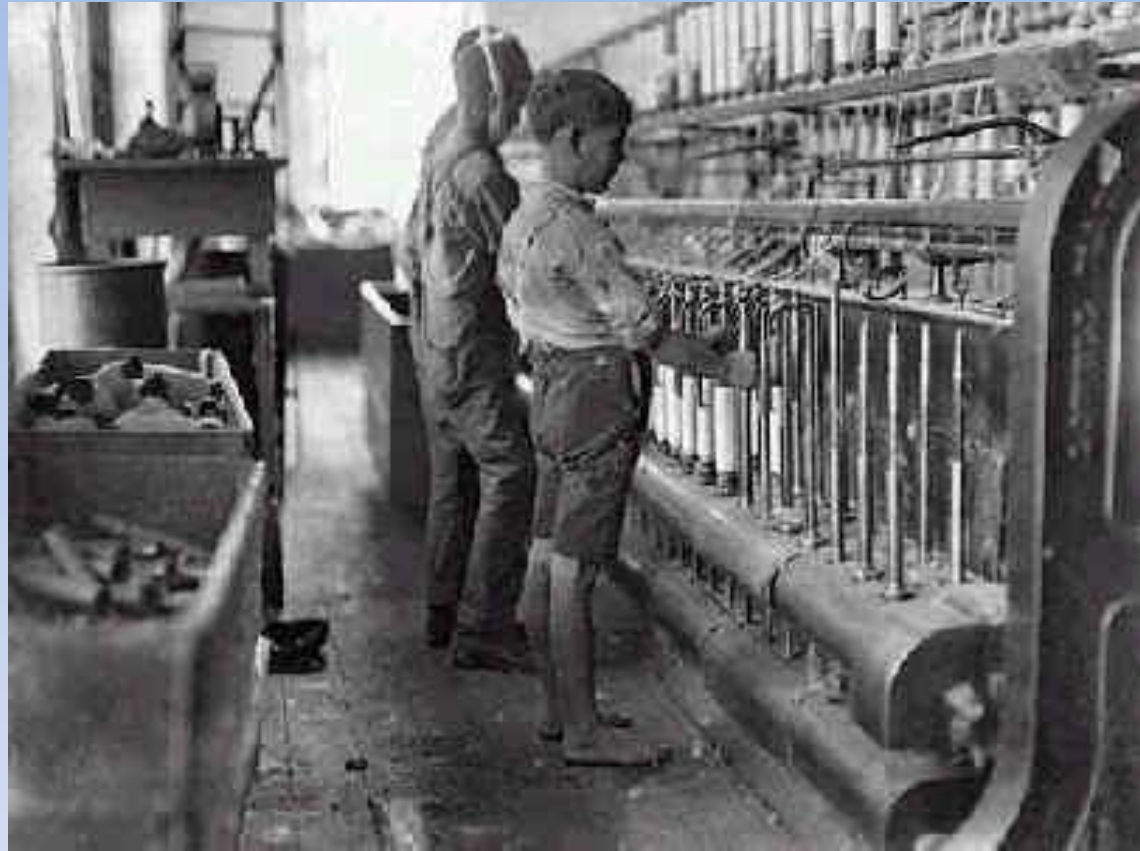

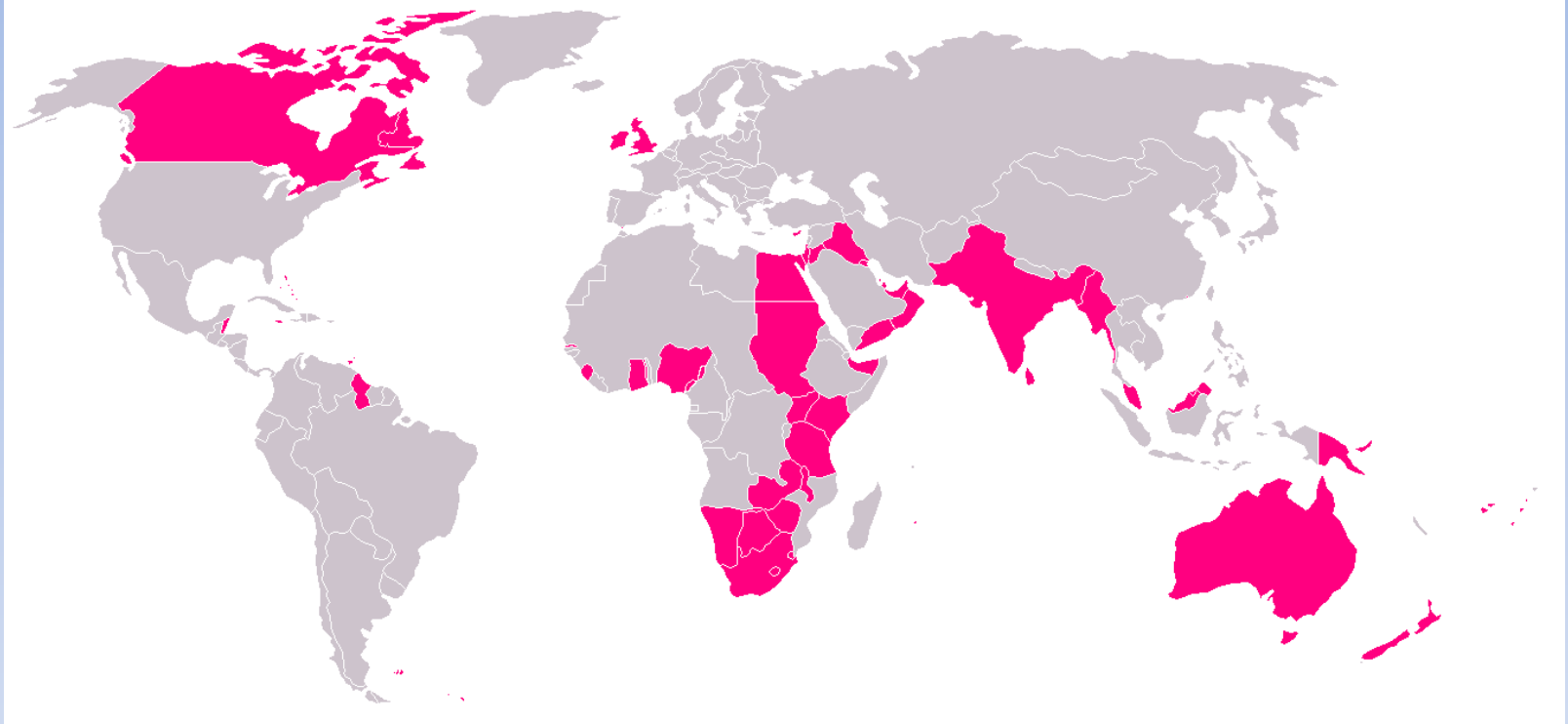











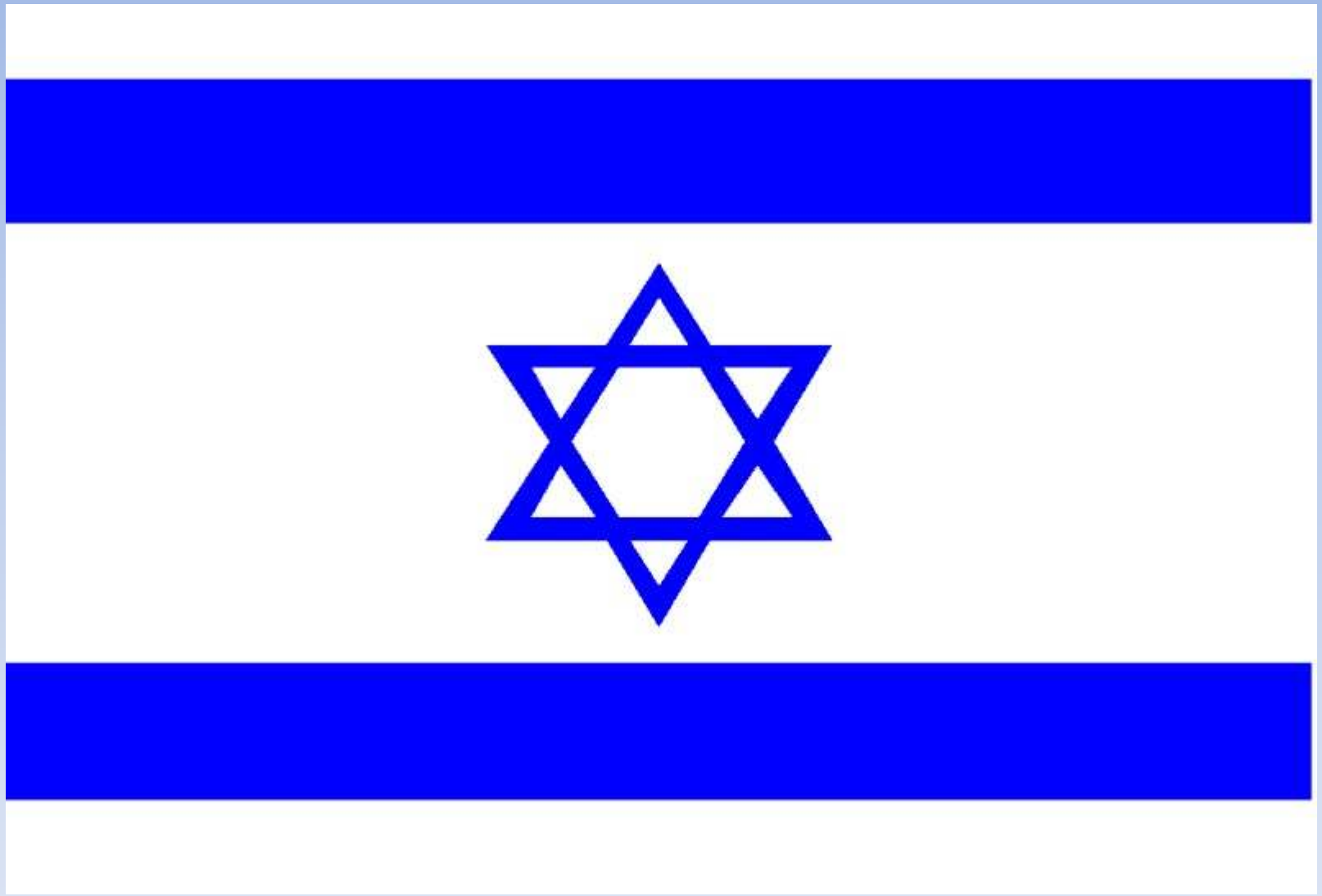





Global warming: Causes and effects

Earth's temperature has risen about 1 degree Fahrenheit in the last century. The past 50 years of warming has been attributed to human activity.

Burning fuels such as coal, natural gas and oil produces greenhouse gases in excessive amounts.

Greenhouse gases are emissions that rise into the atmosphere and trap the sun's energy, keeping heat from escaping.

The United States was responsible for 20 percent of the global greenhouse gases emitted in 1997.

Most of the world's emissions are attributed to the United States' large-scale use of fuels in vehicles and factories.

During the past 100 years global sea levels have risen 4 to 8 inches.

Some predictions for local changes include increasingly hot summers and intense thunderstorms.



Damaging storms, droughts and related weather phenomena cause an increase in economic and health problems. Warmer weather provides breeding grounds for insects such as malaria-carrying mosquitoes.

Source: Environmental Protection Agency

NATE OWENS/STAFF



邓小平

col. SRL









History is about to be rewritten
by two guys who can't spell.

